

Sales Code: SQU108BP

Description: 1000X800x1850mm Offset Quad Enclosure

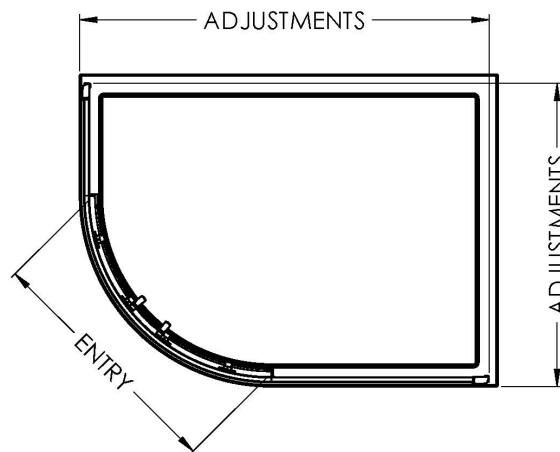
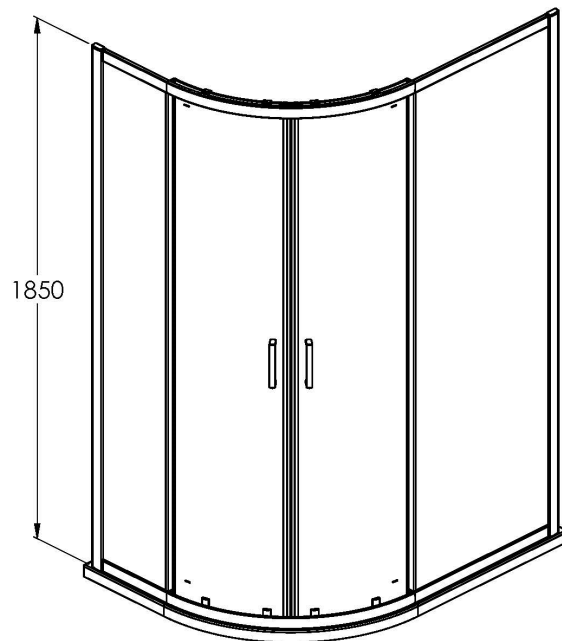

Product Dimensions

Height (mm):	1850
Width (mm):	980
Depth (mm):	780
Nett Weight (kg):	43.5

Packaging Dimensions

Height (mm):	1910
Width (mm):	450
Length (mm):	110
Gross Weight (kg):	48.5

Packaging Data

Box Colour:	Brown Cardboard Box - Printed
Box Qty:	1
Label Size:	100 x 50
Label Colour:	Not Applicable
Label Qty:	0

Outer Box Dimensions (If Applicable)

Height (mm):	
Width (mm):	
Depth (mm):	
Length (mm):	
Gross Weight (kg):	
Barcode:	5056462643489

Product Details

Country of Origin:	China
Fitting Instruction:	No
CE & UKCA:	No
Profile Material:	Aluminium
Profile Finish:	Matt Black
Adjustments (mm):	975 - 995mm / 775 - 795mm
Entry Width (mm):	480mm
Swing In Dim (mm):	N/A
Swing Out Dim (mm):	N/A
Radius (mm):	538 mm
Glass Thickness (mm):	6
Easy Fit:	Yes
Easy Clean:	No
Handle Style:	Square T Shape Handle
Handle Material:	ABS
Enclosure Design:	Framed
Wheel Type:	Dual, Quick Release
Support Bar Included:	Support Bar Not Included
Extras:	None