

Sales Code: NTP114

Description: Offset Quad Tray Lh 1200 X 900

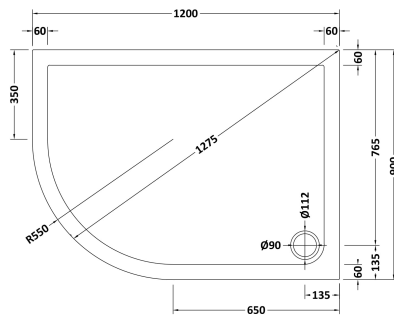

Product Dimensions

Length (mm):	0
Width (mm):	0
Height (mm):	0
Nett Weight (kg):	26.08

Packaging Dimensions

Length (mm):	1240
Width (mm):	940
Height (mm):	80
Gross Weight (kg):	26.1

Packaging Data

Box Colour:	Shrinkwrap & Polystyrene
Box Qty:	0
Label Size:	0 x 0
Label Colour:	White Label
Label Qty:	0

Outer Box Dimensions (If Applicable)

Length (mm):	
Width (mm):	
Height (mm):	
Gross Weight (kg):	
Barcode:	5055369006175

Product Details

Country of Origin:	United Kingdom
Fitting Instruction:	Yes
CE & UKCA:	Yes
Colour/Finish:	White
Product Material:	Acrylic Capped ABS Caco3 & Pu
Material Colour Reference:	European White
Radius:	0
Waste Required (mm):	0
Compatible with Leg Kit:	Yes